

# LAYERS OF ROOFING



## 1 ROOFING

- The outermost layer (tiles, metal sheets, or shingles).
- Protects the building from rain, sun, and wind.
- First barrier against weather.
- Should be durable and waterproof.

## 2 STEEL TRUSS

- Structural framework that supports the roof.
- Made of steel for strength and durability.
- Distributes the load of roofing materials evenly.
- Resistant to termites and rot (better than wood).

## 3 ALUMINIUM INSULATION

- Reflective insulation layer (often foil-based).
- Reflects heat from the sun, reducing indoor temperature.
- Helps improve energy efficiency (less need for cooling).
- Also acts as a moisture barrier.

## 5 MESH

- Wire mesh layer that supports insulation materials.
- Prevents insulation (like rockwool) from sagging or falling.
- Allows ventilation and airflow.
- Adds stability to the system.

## 6 CEILING PANEL

- The visible interior ceiling (e.g., gypsum board, metal panels).



# BAMBOO & CLASSIC TILE

## Bamboo Tile I

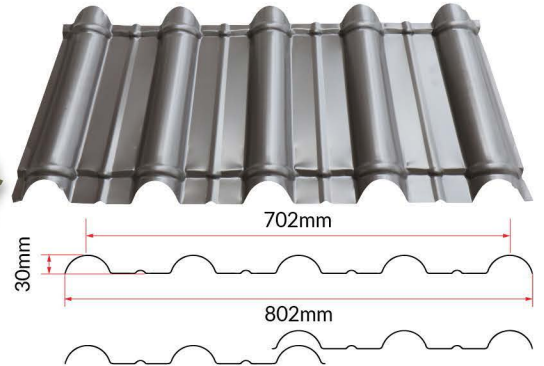

## Bamboo Tile II

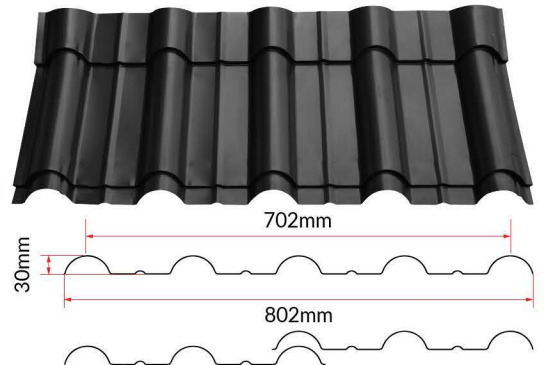

## Classic Tile

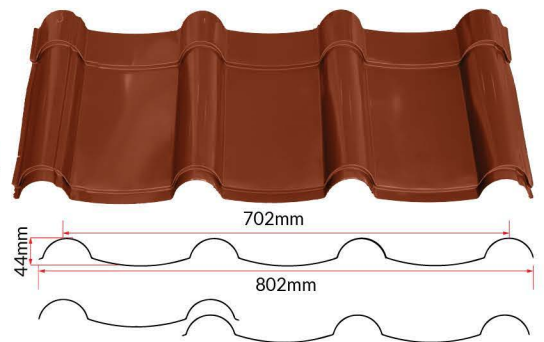

# SPANLOK 3

## Projects using our Roofing

Spanlok Roofing features a concealed-fix profile with bold ribs for added strength and water-tightness. Engineered for long spans and minimal maintenance, it ensures superior wind uplift performance and thermal movement control—perfect for high-rainfall regions.

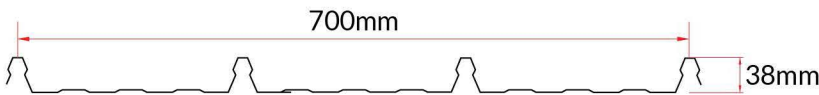

### Fasteners

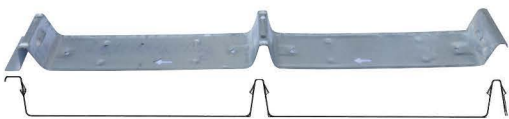

HSRM For I-CLIP™ Roofing Fasteners for Clip



HSRM Anti Rust Self Drilling Screw for Metal  
 #12-24X25MM  
 #12-18X55MM  
 #12-18X65MM



HSRM Flat Head Wafer Drilling Screw  
 #10-24X16MM  
 #10-24X20MM  
 #10-24X25MM  
 #10-24X38MM



HSRM Anti Rust Self Drilling Screw w/o Washer for Metal  
 #10-24X16MM  
 #10-18X20MM

### RECOMMENDED SUPPORT SPACING

TOTAL COATED THICKNESS (MM)	MINIMUM RECOMMENDED PITCH DEGREE	MAX ROOF OVERHANG UNSUPPORTED (MM)	MAX ROOF OVERHANG W/ 50mm*50mm*1.6mm ANGLE & GUTTER	ROOFS			WALLS		
				SINGLE SPAN (MM)	END SPAN (MM)	INTERNAL SPAN (MM)	SINGLE SPAN (MM)	END SPAN (MM)	INTERNAL SPAN (MM)
				0.47	5°	250	300	1500	1200
0.40	5°	250	250	1350	1000	1550	1600	1300	1800

# SPEEDECK I & SPEEDECK II

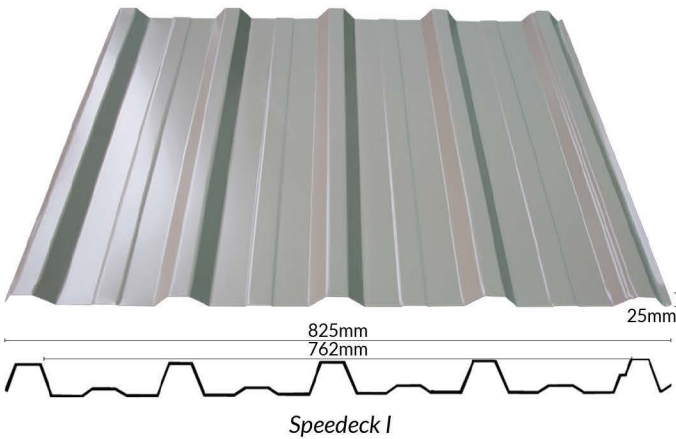

Speedeck I

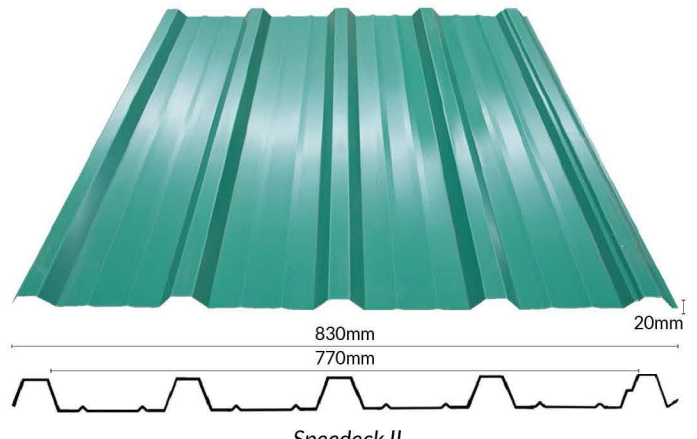

Speedeck II

## STEEL BATTENS

### RECOMMENDED SIZE

Rafter Centers	Batten Size
Up to 2000mm	HB25
Up to 2700mm	HB40
Up to 3500mm	HB60

## STANDARD MATERIAL SPECIFICATION

Aluminium-Zinc Coating	55% Aluminium-Zinc Alloy Coating
Paint Coating	Top: 20 Microns Todo RP/SMP Paint Back: 5 Microns Corrosion, Inhibitive Coat
Roof Pitch	Suitable for any roof slope from 15 degrees
Tolerance	Thickness: +/- 0.02mm Cover Width: +/- 2mm

## RECOMMENDED SUPPORT SPACING

TOTAL COATED THICKNESS (MM)	MINIMUM RECOMMENDED PITCH DEGREE	MAX ROOF OVERHANG UNSUPPORTED (MM)	MAX ROOF OVERHANG W/ 50mm*50mm*1.6mm ANGLE & GUTTER	ROOFS			WALLS		
				SINGLE SPAN (MM)	END SPAN (MM)	INTERNAL SPAN (MM)	SINGLE SPAN (MM)	END SPAN (MM)	INTERNAL SPAN (MM)
0.47	3°	250	300	1500	1200	1750	1800	1500	2000
0.40	3°	250	250	1350	1000	1550	1600	1300	1800
0.30	3°	200	200	1000	900	1200	1400	1000	1600

# CRIMPCURVE

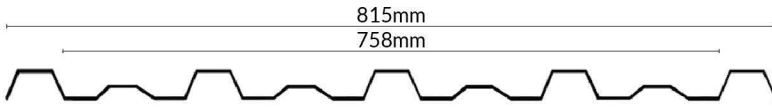
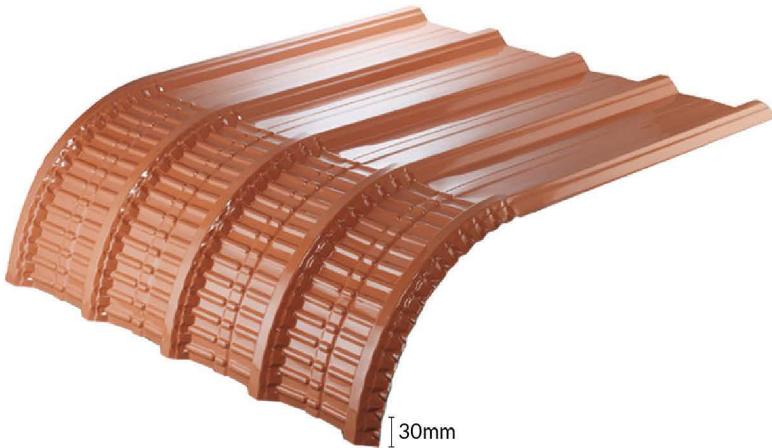

When installing the crimp curve roofing, it's essential that each run of curved and straight sheets are end-lapped progressively across the width of the roof so they can kept in alignment. For best results, sheets should be laid in the order illustrated in the diagram. A carpenter's level should be used to lay the first sheet. Always measure every 3rd or 4th sheet to check square. A rope with a hook at one end may be on the overlap side of the sheet to obtain a good lap.

Important note: There is at least 100mm at the end adjacent to the curve which cannot be curved. This must be taken into account when measuring.

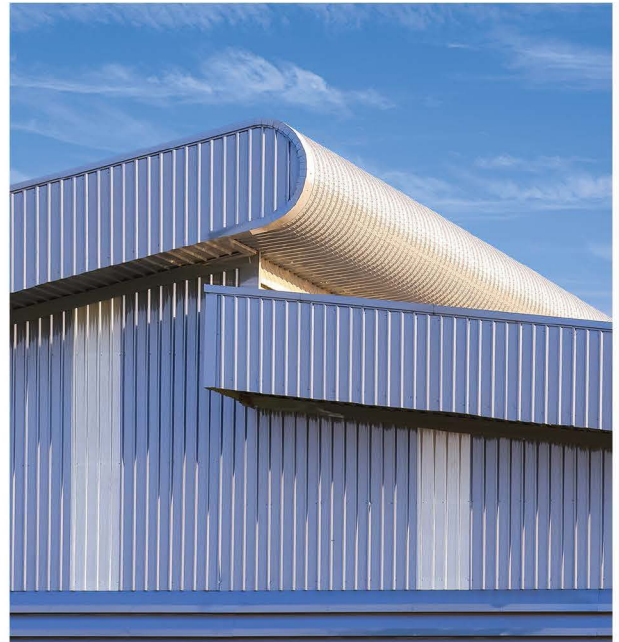

## Fastener Frequency & Location

Support Location	Fasteners Per Sheet	Location of Crest Fasteners for Roofs & Walls & Valley Fasteners for Wall	Minimum Length of Crest Fasteners		Side Lap Fastener Spacing
			Steel Supports	Timber Supports	
Internal End and Lap Support	4	Crest	Thread-rolling screw 50mm	Wood screws 60mm+ Self-drill wood screw type 1765mm	Mid span for Purpline spacing over 900mm and girt spacing over 1200mm
			Self-drill thread forming screw 45mm+		
		Valley	Self-drill thread forming screw 50mm+		Also at supports for valley fastened sheeting

# HSRM WALL PANEL

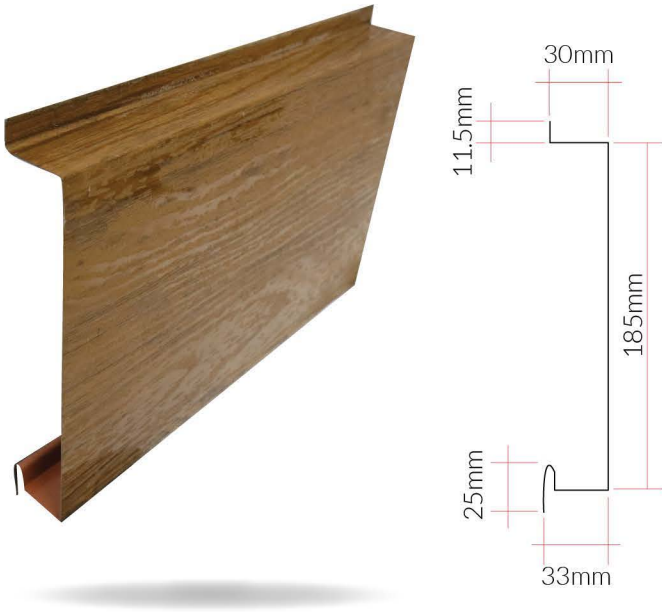

Wall panels are decorative or functional coverings used to enhance interior walls. They come in various materials like wood, PVC, MDF, fabric, and metal, and can provide insulation, soundproofing, and moisture resistance. Wall panels are often used to improve aesthetics, hide imperfections, or add texture and depth to a space. They are easy to install and are popular in both residential and commercial interiors.

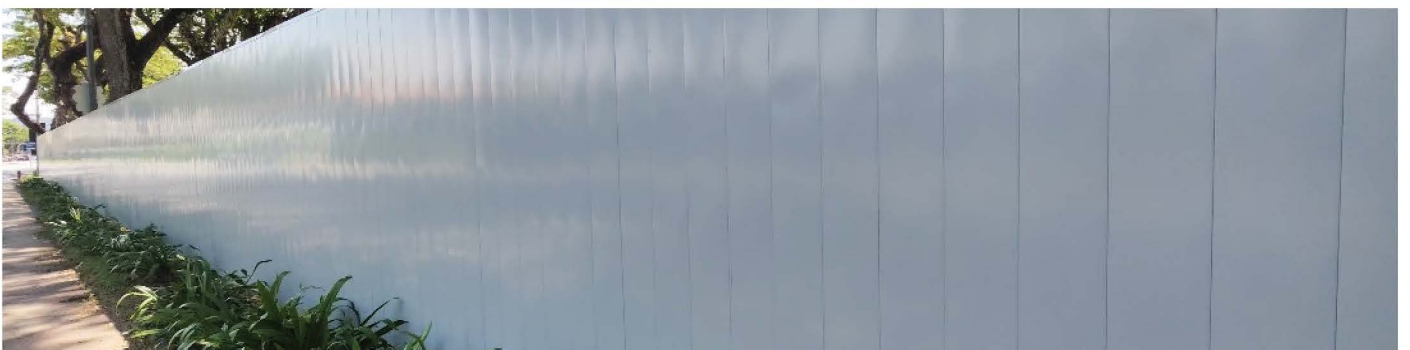

# FASCIA BOARD

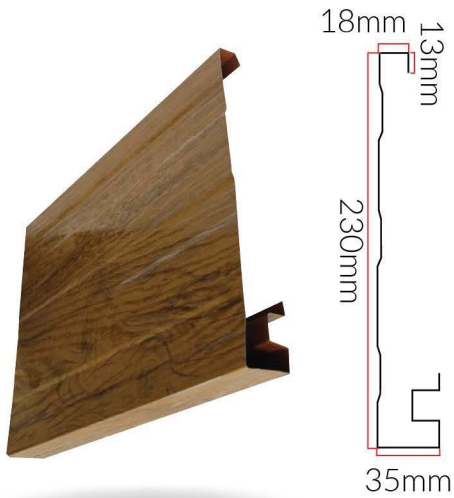

Fascia board enhances home's curb appeal while providing essential protection to roof and gutter system. It prevents water damage by covering the rafter ends & supports gutters, ensuring proper water drainage. Made from durable materials, it's a low maintenance upgrade that boosts functionality & aesthetics.

*FASCIA  
BOARD*

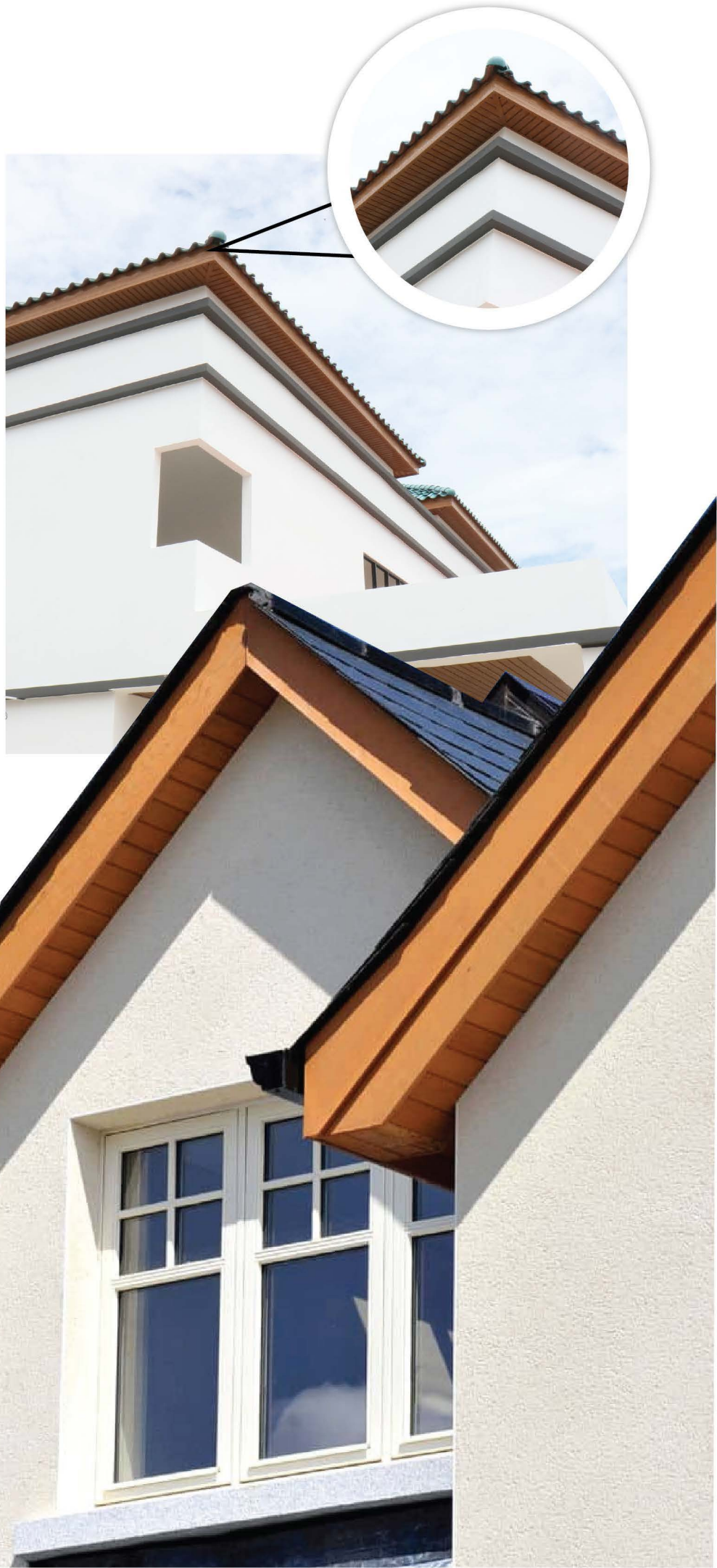

# CEILING PANEL



**730 CEILING PANEL**

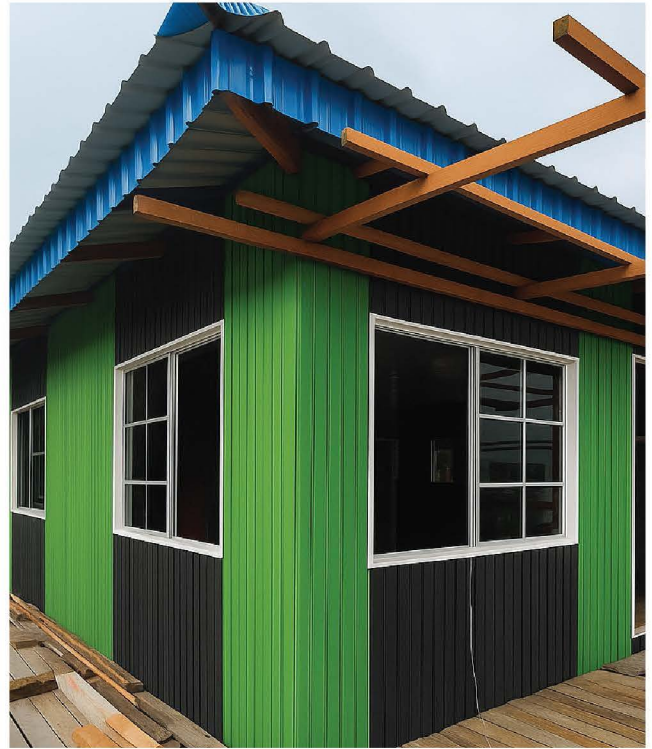

**Z130 HSRM CEILING PANEL**

Ceiling panels are lightweight boards used to cover ceilings for both decorative and functional purposes. Commonly found in homes and commercial spaces, they help improve acoustics, hide wiring, and enhance room aesthetics. Available in materials like gypsum, PVC, metal, and mineral fiber, ceiling panels can offer properties such as fire resistance, moisture resistance, and sound insulation. They are often installed in suspended ceiling systems for easy access and maintenance.

**“ Help hides wiring & enhance room aesthetics.”**

## T195 PARTITION PANEL

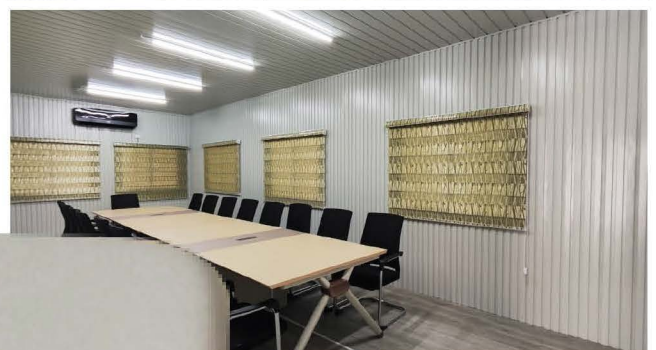
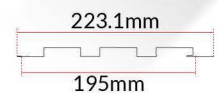

Partition panels can blend seamlessly with different interior designs. They are easy to install, often without the need for permanent construction and provide a cost-effective alternative to building permanent walls.



# PARTITION PANEL

Partition panel fences are modular fencing systems designed for space division, privacy, and security in residential, commercial, or industrial settings. Made from durable materials such as metal, PVC, or composite panels, they offer a sleek and functional design. Easy to install and customizable in size and finish, these panels are ideal for creating temporary or permanent boundaries, both indoors and outdoors. Waterproof and designed with a premium finish for durability and elegance on your fencing. It comes with varieties of colors too.

## M112 PARTITION PANEL

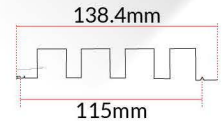

HOT DIPPED FENCE **POST**  
(SQUARE/RECTANGLE HOLLOW PIPE)

HSRM M-PANEL OR T-PANEL



# STEEL TRUSS

A steel truss is a structural framework of interconnected steel members arranged in a triangulated pattern. This geometric design allows the structure to distribute heavy loads efficiently by converting them into pure axial forces—tension and compression—minimizing material usage while maximizing strength.

## Core Components

A standard truss typically consists of three primary elements:

- **Top Chord:** The uppermost line of members, usually carrying compressive forces.
- **Bottom Chord:** The lowermost members that act as a tie beam, primarily under tension.
- **Web Members:** The internal bracing (verticals and diagonals) that connects the chords and distributes the load.
- **Nodes/Joints:** The specific points where these members meet and are joined via welding, bolting, or gusset plates.

## Key Applications

- Steel trusses are the preferred structural solution for projects requiring expansive, open areas:
- **Infrastructure:** Bridges (pedestrian and railway), transmission towers, and stadium canopies.
- **Commercial & Industrial:** Aircraft hangars, warehouses, manufacturing plants, and airport terminals.
- **Specialized Buildings:** Churches (using scissor trusses) and agricultural storage like barns or riding arenas.

## Why steel truss is popular

- ✓ Very strong but lightweight
- ✓ Covers long distances without columns
- ✓ Saves steel compared to solid beams
- ✓ Easy to prefabricate and install
- ✓ Good resistance to bending and wind loads



# **ALUMINIUM BUBBLE FOIL** **SAVE YOUR ENERGY BILLS**

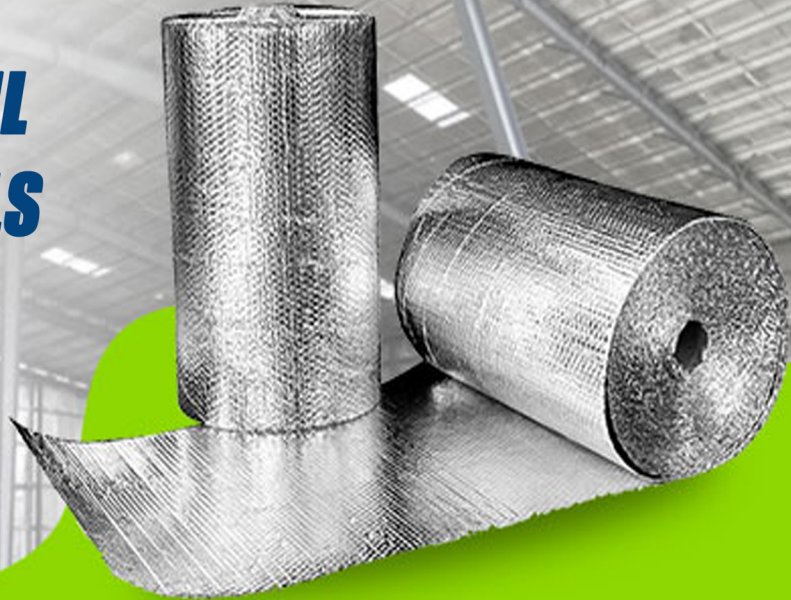

## **PRODUCT FUNCTION**



**High Quality Reflective  
Insulation Foil**

**Waterproof And  
Moistureproof**

**Easy to Cut  
And Install**

**Heat Shield  
Sound Deadener**

# ROCKWOOL

## Why do we need internal wall insulation?

Introducing high quality interior wall insulation is one of the best ways to prevent loss of circulated cool air, protect against fire risks, and improve acoustic capabilities.

It improves energy performance and creates a comfortable home or working environment suitable for all types of internal walls:

- **Partition walls** - Non-load bearing walls used to divide a room. Commonly a wooden or metal stud wall with plasterboard finish or similar.
- **Dry lining walls** - Similar in build to a partition wall, but placed on the inside of the outer wall. This type of internal wall is designed around improving comfort.
- **Separation walls** - Also known as a party wall, these separate adjoining flats, houses and rooms between residential properties.

Applications can be easier and more accessible for certain properties, such as flats. They also have no impact on the external appearance, such as with dry lining walls where the insulation can be installed before the cladding, which is then painted over.

For separation and partition walls, they improve the soundproof qualities between rooms and properties.

Benefits of ROCKWOOL internal wall insulation include:

- Reduced heat gained
- Protection against fire risks
- Cost-effective installation
- Blocking and absorbing sound
- Matching environment aesthetics



## Why do we need ceiling or soffit insulation?

As cool air rises, it will easily escape through an uninsulated ceiling/soffit. The same is true for both sound and fire.

Insulated ceiling panels, tiles and grid suspension systems - as well as our other forms of insulation products - can improve the thermal comfort, acoustic performance and fire safety of entire rooms and floors. For information on ceiling panels learn more about ROCKFON - part of the ROCKWOOL Group.

Buildings with internal insulation can deliver significant energy savings and greater thermal performance, making multi-storey developments comfortable for living and working<sup>1</sup>.

There are three main types of ceiling or soffit insulation:

- **Car park ceiling** - High density boards with an optional coating or wood-fibre finish that can be painted or plastered. Boards are glued or mechanically fixed to the ceiling. This enhances the ceiling's aesthetics as well as its thermal, acoustic, and fire resilience - ideal for protecting properties above.
- **Basement or cellar ceiling** - Very similar to the car park ceiling products, but with a greater focus on domestic use and requirements.
- **Suspended ceiling** - Commonly used in intermediate floors, a new ceiling is created underneath the load bearing floor from a wooden or metal structure. Light weight rolls or slabs are applied to improve the thermal, acoustic, and fire performance.

Benefits of ROCKWOOL ceiling or soffit insulation include:

- Cool retention<sup>2</sup> - stopping cool air from passing through a floor
- Acoustic absorption<sup>2</sup> - eliminating long reverberation time
- Fire resilient properties<sup>3</sup> - reducing the risk of a fire spreading
- Reduced energy bills - which can help alleviate financial issues associated with hot homes<sup>4</sup>



# BRC MESH

BRC 3315 refers to a specific type of galvanized welded wire mesh primarily used in the construction and roofing industries, particularly across Southeast Asian markets.

## Key Specifications

The name "3315" often corresponds to its standard physical dimensions:

- **Mesh Opening:** 75mm x 75mm (approximately 3 inches' x 3 inches)
- **Wire Diameter:** Typically ranges from 1.2mm to 1.5mm
- **Standard Roll Size:** Usually 1.8metres in width and available in lengths of 15m, 18m, 25m or 30m
- **Material:** Made from galvanized iron or steel wire, often hot-dipped after welding for superior corrosion and rust resistance.

## Primary Applications

**Roofing Support:** It acts as a durable framework to support roofing underlay, glass wool, or rock wool insulation.

**Concrete Reinforcement:** Used in concrete structures and exterior walls to enhance structural integrity and reduce slab sag.

**Safety & Protection:** Serves as a fall protection barrier for workers during roof installation and prevents pests or debris from entering roof structures.

**Agriculture & Fencing:** Utilized for security barriers, poultry enclosures (like chicken coops), and garden protection

## Benefits

**Durability:** The hot-dipped galvanized coating ensures long-lasting performance even in harsh outdoor environments.

**Thermal Efficiency:** Facilitates proper airflow and ventilation, which helps reduce heat build-up and improves energy efficiency in buildings.

**Easy Handling:** It is lightweight, sturdy, and easy to cut, making it simple to install for both residential and industrial projects.

